

ergotron®



**TRACE** THE MOVEMENT



# TRACE™

An agile workforce requires agile workspaces. The innovative TRACE Monitor Mount creates dynamic office environments that meet the needs of evolving workstyles to positively impact employee performance, well-being and satisfaction. Unhindered monitor adjustment allows each user to embrace their next move with a natural home position that brings uniformity to modern office designs.

Set apart from traditional monitor arms, the award-winning TRACE Monitor Mount is designed with distinct vertical and lateral movements to move in a straight line. It traces the user movement along this path to effortlessly transition between individual and collaborative work, always returning to the personalized home position.

TRACE is a hybrid of Ergotron's best technologies and new innovations. Patented Constant Force™ Technology paired with a linear guide system allows for smooth monitor adjustment and 240 degrees of pan for an ergonomic set-up. In personal or shared workspaces, users can work sitting or standing with their monitors at a customizable height to support the ideal posture for comfortable working.

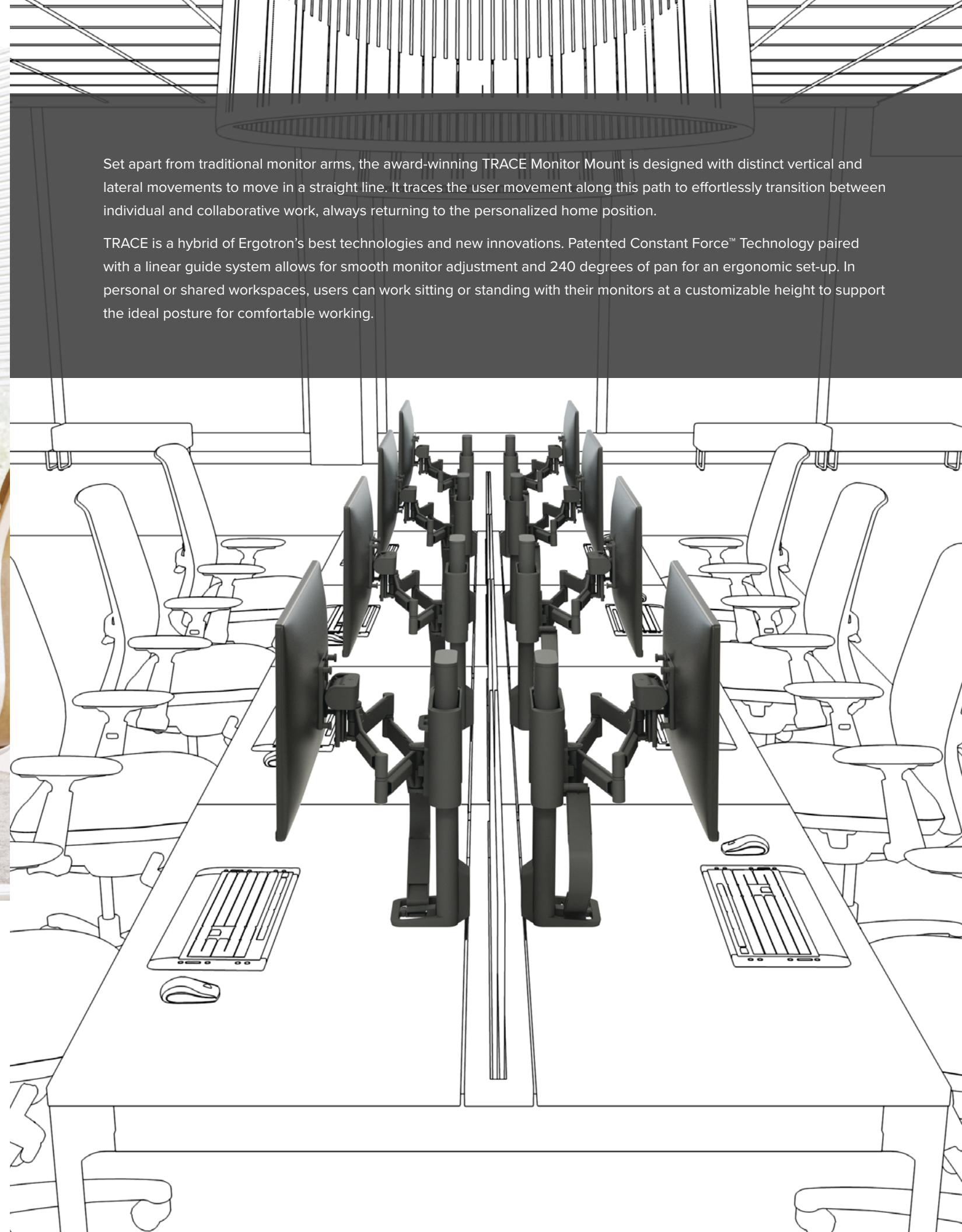

*Embrace the Technology of Movement™ to improve workplace comfort, collaboration and productivity.*

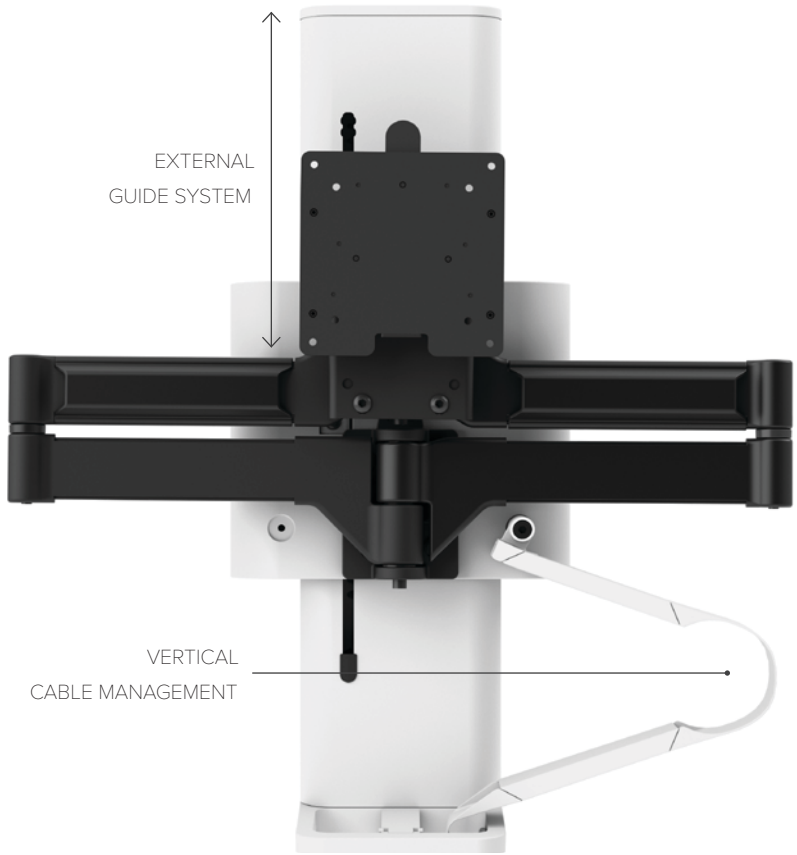

The understated aesthetic complements the modern look of home and office environments while keeping real human needs at the center. In the home office, TRACE offers the flexibility to shape each user's own experience by putting health, creativity and style first.

In the corporate office, TRACE adds refinement and uniformity with integrated cable management that helps eliminate clutter and expose more usable workspace. The set path ensures monitors do not interfere with panel systems, aisles or walls, with the home position visually centered on the workspace.





Installers can efficiently outfit a full office or integrate a single product. The quick attach system supports easy monitor attachment with a counterbalance indicator for precise and personalized set-up. System modularity allows for long-term flexibility with available accessories to transition between single and dual displays based on changing user needs.

The modular design accommodates new technology or workplace upgrades. BIFMA level® 2 and Clean Air GOLD certifications—together with a premium, 15-year warranty and professional-grade quality testing for 15,000 cycles—elicit confidence in a long-term investment that contributes to sustainability initiatives.

TRACE IS A HYBRID OF ERGOTRON'S BEST TECHNOLOGIES AND NEW INNOVATIONS, OFFERING USERS THE FREEDOM TO MEET THE NEEDS OF THEIR UNIQUE WORKSTYLES.



# YOUR SYSTEM YOUR DESIGN

## Single Monitor Mount



with Panel Clamp  
45-630-224 (Matte Black)



with Panel Clamp  
45-630-216 (White)

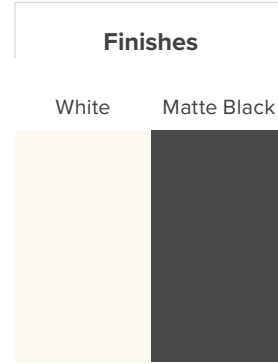

## Dual Monitor Mount



with Panel Clamp  
45-631-224 (Matte Black)



with Panel Clamp  
45-631-216 (White)



As awarded by  
The Chicago  
Athenaeum:  
Museum of  
Architecture and  
Design

## Single Conversion Kit



47-109-224 (Matte Black)

## Dual Conversion Kit

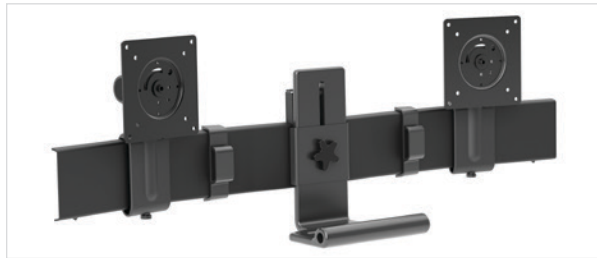

47-110-224 (Matte Black)

## Clamp Kit



Grommet  
98-492-009 (Matte Black)



Slim Profile  
98-490-224 (Matte Black)



Slim Profile  
98-490-216 (White)

Download additional resources at [ergotron.com](http://ergotron.com).

For more information:

USA & Canada: 800.888.8458 / +1.651.681.7600 / [insidesales@ergotron.com](mailto:insidesales@ergotron.com)

EMEA: +31.33.45.45.600 / [info.eu@ergotron.com](mailto:info.eu@ergotron.com)

APAC: [apaccustomerservice@ergotron.com](mailto:apaccustomerservice@ergotron.com)

LATAM: +1.800.681.1820 / [info.latam@ergotron.com](mailto:info.latam@ergotron.com)

Custom: [custom@ergotron.com](mailto:custom@ergotron.com)

© Ergotron, Inc. 02.07.2022

Literature made in the USA

Content subject to change.

Ergotron devices are not intended to cure, treat, mitigate or prevent any disease.

Patent information available at [www.ergotron.com/patents](http://www.ergotron.com/patents).

ergotron®