

FUJITSU Display B23T-7 LED



Congratulations on your purchase of an innovative product from Fujitsu.

Latest information about our products, tips, updates etc. can be found on the Internet at: ["http://www.fujitsu.com/fts/"](http://www.fujitsu.com/fts/)

You can find driver updates at: ["http://support.ts.fujitsu.com/download"](http://support.ts.fujitsu.com/download)

Should you have any technical questions, please contact:

- our Hotline/Service Desk (see the Service Desk list or visit: ["http://support.ts.fujitsu.com/contact/servicedesk"](http://support.ts.fujitsu.com/contact/servicedesk))
- Your sales partner
- Your sales office

We hope you enjoy working with your new Fujitsu system!



Published by / Contact address in the EU

Fujitsu Technology Solutions GmbH

Mies-van-der-Rohe-Straße 8

80807 Munich, Germany

["http://www.fujitsu.com/fts/"](http://www.fujitsu.com/fts/)

Copyright

© Fujitsu Technology Solutions GmbH 2014. All rights reserved.

Publication Date

03/2014

Order No.: A26361-K1496-Z320-1-7619, edition 1

FUJITSU Display B23T-7 LED

Operating Manual

Your LCD screen...	5
Important notes	7
Getting started	11
Operation	19
Notes on ergonomic colour adjustment	31
Troubleshooting	32
Explanatory information about standard ISO 9241-307	34
Technical specification	35

Remarks

Notes on the product description meet the design requirements of Fujitsu and are provided for the purposes of comparison. The actual results may differ due to several factors. Subject to technical changes without prior notification. Fujitsu accepts no responsibility for technical or editorial mistakes or omissions.

Trademarks

Fujitsu and the Fujitsu logo are registered trademarks of Fujitsu Limited or its subsidiaries in the United States and other countries.

Microsoft and Windows are trademarks or registered trademarks of the Microsoft Corporation in the United States and/or other countries.

VESA, DDC and DPMS are registered trademarks of Video Electronics Standards Association.

All other trademarks specified here are the property of their respective owners.

Copyright

No part of this publication may be copied, reproduced or translated without the prior written consent of Fujitsu.

No part of this publication may be saved or transmitted by any electronic means without the written consent of Fujitsu.

Contents

Your LCD screen...	5
Target group	5
Further information	6
Notational conventions	6
Important notes	7
Safety instructions	7
Power cable	8
Transporting the device	8
Cleaning the device	9
CE marking	9
Disposal and recycling	10
Getting started	11
Unpacking and checking the delivery	11
Setting up the device	11
Setting up an ergonomic video workstation	12
Mounting the monitor base	14
Adjusting height	15
Adjusting the inclination	15
Adjusting the rotation	15
Removing monitor base	16
Connecting the device	16
Connecting cables to the computer	18
Operation	19
Switching the device on and off	19
Notes on power management	21
Changing the monitor settings	21
Changing the monitor settings with the buttons of the control panel	22
Changing the monitor settings using the OSD menu	25
OSD menu functions	26
Adjusting the brightness and contrast	27
Selecting the application mode	27
Setting the screen display	28
Adjusting the volume	28
Setting colour temperature and colours	29
Setting the OSD menu	29
Advanced setting functions	30
Displaying information	30
Notes on ergonomic colour adjustment	31
Troubleshooting	32
Explanatory information about standard ISO 9241-307	34
Technical specification	35
VESA-DDC-compatible VGA interface	36
Preset operating modes	36
Most frequent operating modes	36
SUB D port	37

Contents

DVI-D port 38
DisplayPort socket 39

Your LCD screen...

has a whole range of useful features and functions, e.g.:

- TFT display (Thin Film Transistor; active matrix)
- minimal space requirements thanks to slim casing
- optimum ergonomic characteristics (totally distortion-free, excellent picture definition and colour purity right into the corners)
- high degree of brightness and good contrast
- maximum resolution of 1920 x 1080
- presentation of up to 16.7 million colours (in conjunction with an appropriate display adapter)
- automatic scanning of horizontal frequencies from 30 to 82 kHz and refresh rates (vertical frequencies) from 48 to 76 Hz (absolutely flicker-free)
- digital screen control with microprocessor for storing 31 different display modes
- freely adjustable colour alignment for matching the screen colours to the colours of various input and output devices
- convenient operation via integrated OSD (On-Screen-display) menu
- VESA-DDC compatibility
- VESA-FPMPMI compatibility (Flat Panel Monitor Physical Mounting Interface) – Mounting device for swivel arm or similar accessory
- Plug&Play capability
- digital video inputs (DVI and DisplayPort) with HDCP
- power management for reducing power consumption when the computer is not in use
- Compliance with the recommendations according to TCO 6.0
- the monitor fulfills all GS ("Geprüfte Sicherheit", Certified Security) requirements.

This operating manual contains important information you require to start up and run your LCD monitor.

Control of the LCD monitor requires: a display adapter (screen controller) with a VGA interface, or a digital display adapter with a DVI interface, or a video signal source with a DisplayPort interface. The monitor processes the data supplied to it by the display adapter. The display adapter or the associated driver software is responsible for setting the modes (resolution and refresh rate).

When putting the monitor into operation for the first time, the screen display should be optimally adapted to the display adapter used and adjusted in accordance with your needs (see chapter ["Changing the monitor settings", Page 21](#)).

Target group

You don't need to be an "expert" to perform the operations described here. Nonetheless, it is important to always observe the safety notes given in the operating instructions for the computer and in this manual.

In the event of any problems, please contact your sales office or our Service Desk.







Further information

Details of how you set the resolution and refresh rate are provided in the documentation for your display adapter and the associated driver software.

For ergonomic reasons, we recommend a screen resolution of 1920 x 1080 pixels.

Because of the technology used (active matrix) an LCD monitor provides a totally flicker-free picture even with a refresh rate of 60 Hz.

Notational conventions

	Pay particular attention to text marked with this symbol. Failure to observe these warnings could pose a risk to health, damage the device or lead to loss of data. The warranty will be invalidated if the device becomes defective through failure to observe these warnings.
	Indicates important information for the proper use of the device.
	Indicates an activity that must be performed
	Indicates a result
This font	indicates data entered using the keyboard in a program dialogue or at the command line, e.g. your password (Name123) or a command used to start a program (start.exe)
This font	indicates information that is displayed on the screen by a program, e.g.: <i>Installation is complete.</i>
<i>This font</i>	indicates <ul style="list-style-type: none"> • terms and texts used in a software interface, e.g.: Click on <i>Save</i> • names of programs or files, e.g. <i>Windows</i> or <i>setup.exe</i>.
"This font"	indicates <ul style="list-style-type: none"> • cross-references to another section, e.g. "Safety information" • cross-references to an external source, e.g. a web address: For more information, go to "http://www.fujitsu.com/fts/" • Names of CDs, DVDs and titles or designations of other materials, e.g.: "CD/DVD Drivers & Utilities" or "Safety" Manual
	indicates a button on the monitor, e.g.: 
This font	indicates terms and texts that are emphasised or highlighted, e.g.: Do not switch off the device

Important notes

In this chapter you will find information regarding safety which it is essential to take note of when working with your device.

Safety instructions

This device complies with the relevant safety regulations for data processing equipment, including electronic office machines for use in an office environment. If you have any questions about whether the device can be used in the intended environment, please contact your sales office or our Service Desk.

- The display surface of the device is sensitive to pressure and scratches. You should therefore be careful with the display surface in order to avoid lasting damage (scratches).
- If the device is brought into the installation site from a cold environment, condensation can form. Before operating the device, wait until it is absolutely dry and has reached approximately the same temperature as the installation site.
- When installing and operating the device, please observe the notes on environmental conditions in Chapter ["Technical specification", Page 35](#) as well as the instructions in Chapter ["Setting up an ergonomic video workstation", Page 12](#).
- To ensure sufficient ventilation, the air inlet and outlet openings of the device must be kept clear.
- The device automatically sets itself to the correct voltage within the range from 100 V to 240 V. Make sure that the local mains voltage is neither higher nor lower than this range.
- Ensure that the power socket on the device and the mains outlet are freely accessible.
- The ON/OFF button does not disconnect the monitor from the AC voltage. To completely disconnect from the AC voltage, you must remove the power plug from the power socket.
- The device is equipped with a power cable that complies with safety standards.
- Use the supplied power cable only.
- Lay the cables in such a way that they do not create a hazard (danger of tripping) and cannot be damaged. When connecting the device, observe the relevant notes in chapter ["Connecting the device", Page 16](#).
- No data transfer cables should be connected or disconnected during a thunderstorm.
- Make sure that no objects (e.g. jewellery chains, paper clips, etc.) or liquids get inside the device (danger of electric shock, short circuit).
- The device is not waterproof! Never immerse the device in water and protect it from spray water (rain, sea water).
- In an emergency (e.g. damaged casing, operation controls or cables, penetration of liquids or foreign matter), switch off the device, disconnect the power plug and contact your sales outlet or our Service Desk.
- Repairs to the device must only be performed by qualified technicians. Unauthorised opening and incorrect repair may greatly endanger the user (electric shock, fire risk).
- Only use the screen resolution settings and refresh rates specified in Chapter ["Technical specification", Page 35](#). Otherwise you may damage the device. If you are in any doubt, contact your sales outlet or our Service Desk.
- Use a screen saver with moving images and activate the power management for your monitor to prevent still images from "burning in".

- If you operate the device with the swivel arm or a similar accessory, it must not be turned through 180°.
- The device may only be operated in wide format (0° landscape mode) and high format (90° portrait mode). The buttons are located at the bottom in the middle of the monitor in wide format (0° landscape mode) and at the left-hand side of the monitor in high format (90° portrait mode).
- Store this manual close to the device. If you pass the device on to third parties, you should pass this manual on with it.
- We recommend that you place your device on a durable, non-slip surface. In view of the many different finishes and varnishes used on furniture, it is possible that the feet of the device may mark the surface they stand on.
- Avoid using high volumes for a long period of time, to prevent causing damage to your hearing.
- Warning against excessive volume from headphones: excessive volume from headphones can cause hearing loss. Setting the equaliser to the maximum value increases the headphones output voltage and thus increases the sound pressure.

Power cable

Use the supplied power cable only.

Use the following guidelines if it is necessary to replace the original cable set.

- The female/male receptacles of the cord set must meet IEC60320/CEE-22 requirements.
- The cable has to be HAR-certified or VDE-certified. The mark HAR or VDE will appear on the outer sheath.
- For devices which are mounted on a desk or table, type SVT or SJT cable sets may be used. For devices which sit on the floor, only SJT type cable sets may be used.
- The cable set must be selected according to the rated current for your device.
- If necessary, replace the original power cable with a regular grounded 3-core mains lead.

Transporting the device



Transport all parts separately in their original packaging or in a packaging which protects them from knocks and jolts, to the new site.

Do not unpack them until all transportation manoeuvres are completed.

If the device is brought from a cold environment into the room where it will be used, condensation may occur. Before operating the device, wait until it is absolutely dry and has reached approximately the same temperature as the installation site.

Cleaning the device



Switch off the device and unplug the power plug.

Do not clean any interior parts yourself, leave this job to a service technician.

Do not use any cleaning agents that contain abrasives or may corrode plastic.

Ensure that no liquid enters the device.

The display surface of the device is sensitive to pressure and scratches. Clean it only using a soft, slightly moistened cloth.

The surface of the casing can be cleaned with a dry cloth. If particularly dirty, use a cloth that has been moistened in mild domestic detergent and then carefully wrung out.

CE marking

The shipped version of this device complies with the requirements of European Union directives 2004/108/EC "Electromagnetic compatibility", 2006/95/EC "Low voltage directive" and 2009/125/EC "Ecodesign Directive".

Disposal and recycling

This device has been manufactured as far as possible from materials which can be recycled or disposed of in such a way that the environment is not damaged. The device may be taken back after use to be reused or recycled, provided that it is returned in a condition that befits its intended use. Any components not reclaimed will be disposed of in an environmentally acceptable manner.

The device must be disposed of in accordance with the local regulations for disposal of special waste.

If you have any questions on disposal, please contact your local sales office or our Service Desk, or contact one of the following directly:

Germany	Belgium	Switzerland
Fujitsu Technology Solutions GmbH Remarketing and Recycling D-33106 Paderborn Tel.: +49 5251 / 81 80 10 Fax: +49 5251 / 81 80 15 "http://fujitsu.com/fts/remarketing"	RECUPEL Boulevard Reyers, 80 B-1030 Brussels Tel.: +32 2 / 706 86 16 Fax: +32 2 / 706 86 13 E-Mail: info@recupel.be "http://www.recupel.be"	SWICO Schweizerischer Wirtschaftsverband der Informations-, Kommunikations- und Organisationstechnik A list of the SWICO acceptance locations can be found at: "http://www.swico.ch"
Asia	USA	
Taiwan: Environmental Protection Administration Executive Yuan R.O.C. "http://recycle.epa.gov.tw"	Fujitsu America, Inc. 1250E. Arques Avenue Sunnyvale, CA 94085 U.S.A. Phone No.: (408) 746-6000	

You can also find more information on this at ["http://www.fujitsu.com/fts/about/fts/environment-care/"](http://www.fujitsu.com/fts/about/fts/environment-care/).

Getting started

Unpacking and checking the delivery



The display surface of the device is sensitive to pressure and scratches. Always hold the device by the casing!

The complete device package includes:

- one monitor
- one DVI cable
- one VGA cable
- one USB cable
- one audio cable
- one power cable
- one CD with software and documentation
- one Warranty Booklet
- one "Quick Start Guide" flyer
- one "Safety/Regulations" manual

- ▶ Unpack all the individual parts.
- ▶ Check the contents of the package for any visible damage caused during transport.
- ▶ Check whether the delivery conforms to the details in the delivery note.
- ▶ Should you discover that the delivery does not correspond to the delivery note, notify your local sales outlet immediately.



Do not discard the original packing material of the devices. You may need the packaging in the future if you need to transport your device.

Setting up the device



To ensure sufficient ventilation, the air inlet and outlet openings of the device must be kept clear.

Setting up an ergonomic video workstation

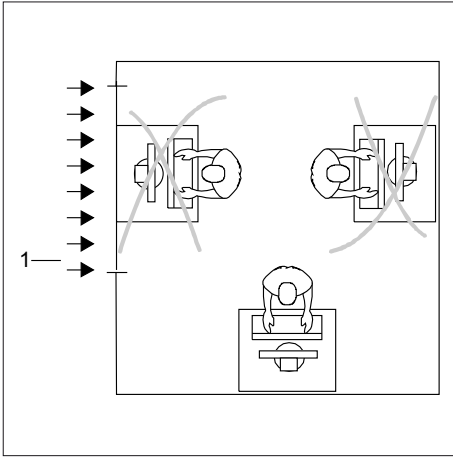

- ▶ Do not position the video workstation opposite a window (1).

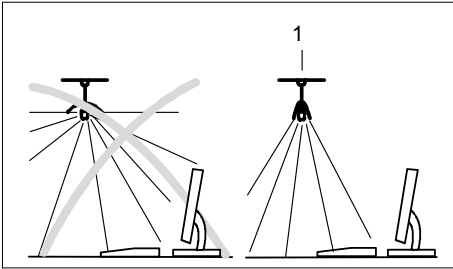

- ▶ Position the monitor outside the reach of a light source (1).



- ▶ Position the keyboard where it is easiest to reach (1).

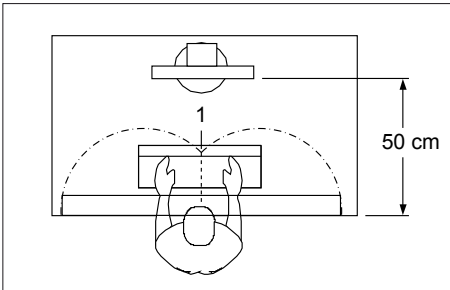

- Position the monitor so that the eye distance to the screen (1) is around 50 cm.

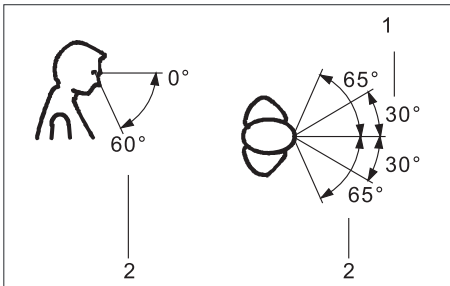

- Position the monitor for optimum viewing (1). The monitor should under no circumstances fall outside the permissible viewing space (2).

i

Depending on the situation, it may be advisable to use a swivel arm or a similar accessory (VESA FPMPMI), which are available from specialist dealers. For this purpose the monitor base must be removed beforehand as described in chapter ["Removing monitor base", Page 16](#).

Mounting the monitor base



Do not remove the retaining splint until you have secured the base plate on the monitor and moved it into the operating position.

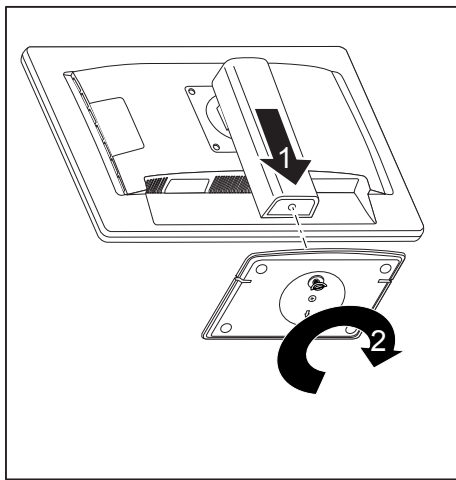

- ▶ Insert the base plate on the foot (1).
- ▶ Secure the base plate with the screw (2).
- ▶ Place the monitor in the operating position.

Adjusting height



The height adjustment is fixed in the transport position.

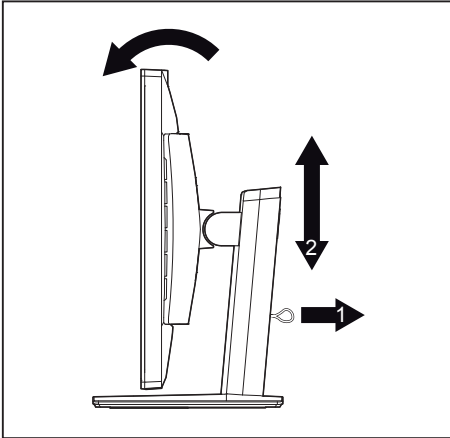

- ▶ To free the fixing, remove the locking pin on the flange (1).
- ↳ The height of the monitor can be adjusted by approximately 130 mm.
- ▶ Grasp the monitor with both hands on the right and left edge of the casing and move it up or down (2).

Adjusting the inclination

The inclination of the monitor can be adjusted by -3° (forwards) and $+35^{\circ}$ (backwards) from its vertical position.

- ▶ Hold the monitor with both hands on the left and right sides of the casing and move it to the desired angle.

Adjusting the rotation

The monitor can be rotated by $\pm 170^{\circ}$.

- ▶ Grasp the monitor with both hands on the right and left edge of the casing and turn it to the desired position.

Removing monitor base

Before you can use a swivel arm or a similar accessory, you must remove the monitor base.



The display surface is susceptible to scratching!

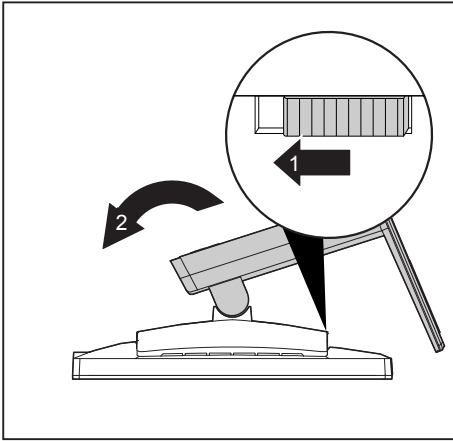

- ▶ Switch off the monitor and pull the power plug out of the power socket.
- ▶ Lay the monitor on its face on a soft surface.
- ▶ Disconnect all cables.
- ▶ Release the base stand by moving the slider in the direction of the arrow (1) and hold it while lifting the complete base stand up (2).
- ↳ You can now mount a swivel arm or a similar accessory in accordance with VESA FPMPMI using a hole spacing of 100 mm.



For instructions on how to mount the swivel arm or a similar accessory, please see the documentation for the swivel arm or similar accessory.

Connecting the device



Please observe the safety information in ["Important notes", Page 7](#).

CE conformance and optimum picture quality are guaranteed only if you use the data cables supplied.

- ▶ Switch off the monitor and the computer.
- ▶ Disconnect the power plug from the computer.

Connecting cables to the monitor

The data cables supplied have two 15-pin D-SUB connectors or two 24-pin DVI connectors for connection to the monitor and to the computer.

Information on the computer connections and interfaces is contained in the operating manual for the computer.

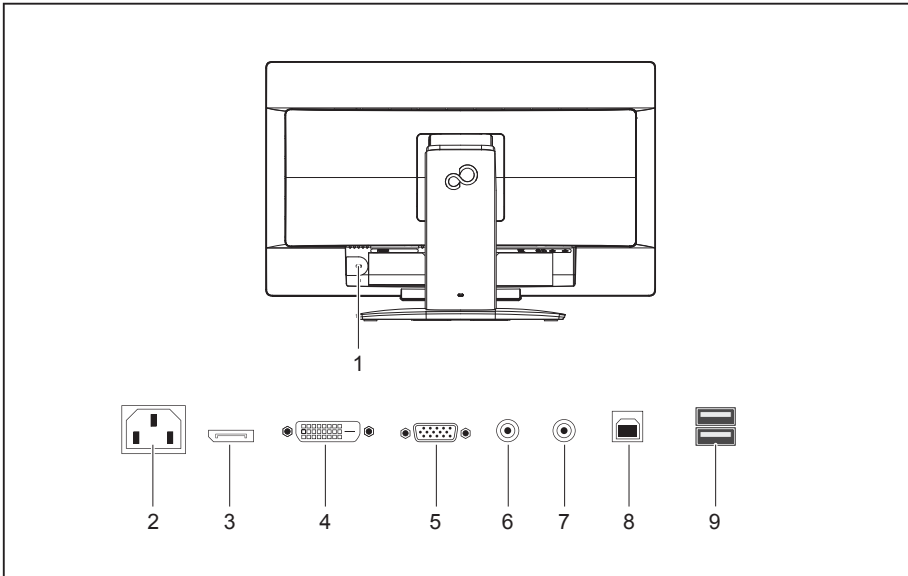

1 = Security slot for "Security Lock"

2 = AC connector socket

3 = DisplayPort socket

4 = DVI-D socket (DVI)

5 = D-SUB socket (VGA)

6 = AUDIO-IN socket

7 = AUDIO-OUT socket

8 = USB 2.0 (upstream)

9 = USB 2.0 (downstream)

- ▶ Select the appropriate data cable for your computer.
- ▶ Connect one of the connectors of the data cable to the DVI-D or DisplayPort socket of the monitor and secure the DVI-D plug-in connection by tightening the safety screws.



The monitor automatically detects the input (VGA, DVI, DisplayPort) when only one signal source is connected.

- ▶ Insert one connector of the audio line into the AUDIO IN socket (6) on the monitor and make sure it is properly engaged.
- ▶ Plug the power cable supplied into the power connector of the monitor.

- ▶ Plug the supplied USB 2.0 cable into the USB 2.0 (upstream) socket (8) and the other end of the cable into a USB 2.0 socket on the computer.



Connect the USB keyboard and USB mouse directly to the PC, as the USB connector socket of the monitor is switched off in PC energy-saving mode.



A lock (Security Lock) can be mounted in the security slot to protect the monitor against theft. A Security lock is not supplied with the monitor.

Connecting cables to the computer

Information on the computer connections and interfaces is contained in the operating manual for your computer.

- ▶ Connect the data cable to the (active) monitor port on the computer and secure the plug-in connection by tightening the safety screws.
- ▶ Insert the other plug of the audio cable in the audio output of the computer.
- ▶ Plug the power connector of the monitor into a properly grounded mains outlet.
- ▶ Plug the power connector of the computer into a properly grounded mains outlet.



If your computer has two monitor ports ("onboard" screen controller and separate graphics card), the monitor port for the separate graphics card is active as standard.

Operation

Switching the device on and off

Version with buttons

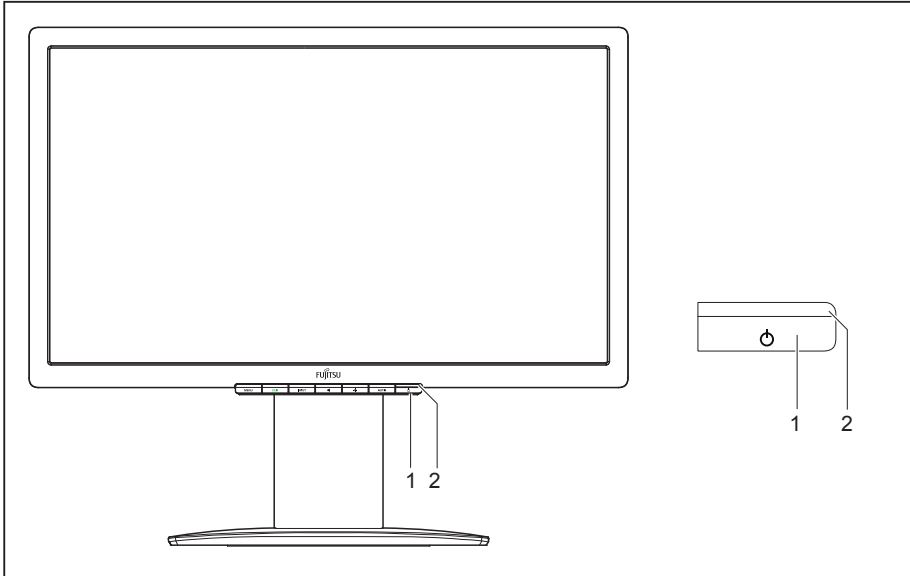

1 = ON/OFF button

2 = Power supply indicator

Version with touch sensors

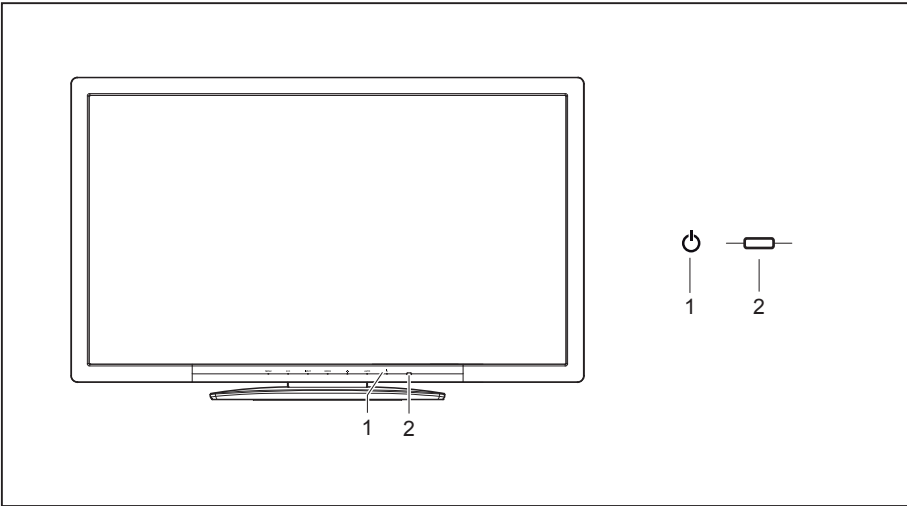

1 = On/Off touch sensor

2 = Power indicator

The colour of the LED indicator changes as follows:

LED indicator	Status
blue	Monitor and computer are switched on (normal mode).
green	Monitor and computer are switched on (ECO mode).
orange	Monitor not receiving a video signal.
does not light up	Monitor is switched off.

- ▶ Switch the device on using the ON/OFF button (1) or the ON/OFF touch sensor (1).

Notes on power management

If your computer is equipped with power management (power saving mode), the monitor can fully support this function. The monitor thereby distinguishes between the individual power saving modes of the computer (standby mode, suspend mode and OFF mode).

Stage	Operation		Power saving mode
	Normal	ECO	
Power supply indicator	Lights up blue	Lit green	illuminated orange
Display	Max. brightness	typ. 200 cd/m ²	unlit
Typical power consumption (without USB and audio)	23 W	19 W	reduced to < 0.35 W

If the computer detects inactivity (no input) it sends an appropriate signal to the monitor to reduce the power consumption (power saving mode). The power indicator of the monitor changes colour to show the change in status. ECO operation is the preset factory default.

Once an input is made at the computer the screen contents are restored.



For detailed information on how energy-saving mode operates, please refer to the operating manual or technical manual of the computer.

Changing the monitor settings

When putting the monitor into operation for the first time, the screen display should be optimally adapted to the display adapter used.



Changing the monitor settings with the buttons of the control panel



Depending on the model, the control panel will either have buttons or touch sensors. In the following sections, only buttons will be mentioned. However, the text also applies to models with touch sensors.

The buttons on the control panel have multiple functions. When the OSD menu is active, the current meaning of the buttons is shown directly over the buttons on the edge of the screen.

The display (softkey icon) over the buttons varies depending on the sub-menu chosen.

Key	Function
MENU	Call up OSD menu
ECO	Activate/deactivate ECO operating mode
INPUT	Select input signal (digital/analog)
	Adjust volume
	Adjust brightness
AUTO	Perform auto-adjustment of the monitor with analog input
	Monitor: switching on/off

Softkey icon	Function
↑	Selecting the next menu item (sub-menu)
↓	Selecting the previous menu item (sub-menu)
→	Opening the selected sub-menu Going to the next setting
←	Going to the previous setting
—	Decreasing the set value
+	Increasing the set value
✓	Accepting the applied settings and returning to main menu
↶	Cancelling the applied settings and returning to main menu
×	Exiting OSD menu
	Loudspeaker: switching off/on



When the OSD menu is not activated, you can apply the following settings directly:

Select OSD language

When an OSD menu button is activated for the first time, the language selection window will appear:

- ▶ Press the ↑ button or the ↓ button to choose the desired language.
- ▶ Press the ✓ button to confirm.



After selecting the OSD language for the first time, you can change it at any time in the OSD.

Activate/deactivate ECO operating mode



The power consumption of the device can be decreased by reducing the brightness of the picture.

- ▶ Press the **ECO** button to switch the ECO operating mode on or off.
 - ↳ The message *ECO Mode on* or *ECO Mode off* is displayed.
- If the ECO operating mode is activated, the following OSD settings are changed:

<i>Mode</i>	Office
<i>Color</i>	6500 K
<i>Brightness</i>	reduced

After the ECO operating mode is switched off, the brightness previously set by the user is restored.

Selecting the input signal

- ▶ Press the **INPUT** button to open the *Input select* setting window.
- ▶ Press the ↑ button or the ↓ button to select the desired monitor connection (VGA, DVI or DP).
- ▶ Press the ✓ button to confirm or the ↶ button to cancel.







This setting window can also be called up when the OSD menu is locked.

Adjusting the volume

- ▶ Press the 🔊 button to open the *Volume* setting window.
- ▶ Press the — button or the + button to set the desired volume for the built-in speakers.
- ▶ Press the 🔇 button to activate/deactivate the mute function.
- ▶ Press the ✕ button to close the menu.

Adjusting the brightness

- ▶ Press the  button to open the *Brightness* setting window.
- ▶ Press the  button or the  button to set the desired brightness.
- ▶ Press the  button to close the menu.

Performing auto-adjustment of the monitor



This function is only intended for analogue image transmission (VGA).

- ▶ Press the **AUTO** button for about 1 second.
- ↳ The *Auto Processing* message appears.
Picture quality and position are set to optimum values for your system.

Locking the OSD menu

The OSD menu can be locked to prevent accidental or unauthorised changes to the monitor settings.

- ▶ Press the **MENU** button and keep it pressed for a few seconds while you switch the monitor on using the ON/OFF button or the ON/OFF touch sensor.
- ↳ The message *OSD locked / unlocked* is displayed.



Please proceed in the same manner to release the locked OSD menu again.

Locking the ON/OFF button or ON/OFF touch sensor

The ON/OFF button or ON/OFF touch sensor can be locked to prevent accidental or unauthorised changes to the screen settings.

- ▶ Press the **ECO** button and **INPUT** button at the same time for a few seconds.
- ↳ The message *Power button locked / unlocked* is displayed.



In order to unlock the ON/OFF button or ON/OFF touch sensor, do the same again.

Changing the monitor settings using the OSD menu

With the buttons on the control panel, you can call up and use the integrated OSD (On-Screen Display) menu.

i

The English menu names are used in the following description (default setting).

The OSD menu of your device may differ in several ways from the functional scope described.

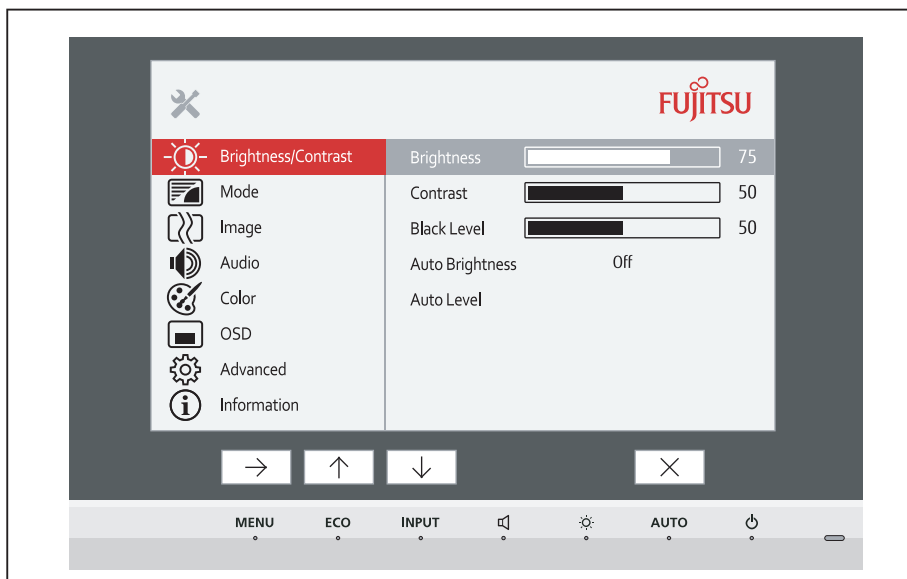

i

The softkey icons may deviate from those shown here.

- ▶ Press the **MENU** button to activate the OSD menu.
- ↳ The OSD menu appears, with menu items for the setting functions.
The first menu item (*Brightness/Contrast*) is highlighted and the associated functions are visible in the right-hand menu field.
- ▶ Press the **↑** button or **↓** button to highlight another icon (e.g. *Image*).
- ▶ Press the **→** button to select the highlighted icon.
- ↳ The *Image* setting window will be displayed.
- ▶ Press the **×** button to close the OSD menu.

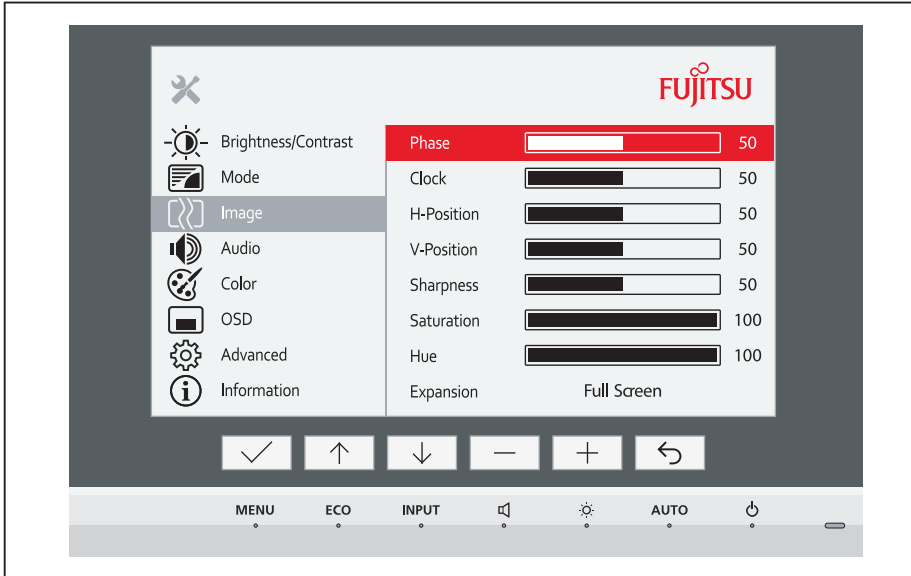

- ▶ Press the ↑ button or ↓ button to highlight another function.
- ▶ Press the + button or the - button to change the setting.
- ▶ Press the ✓ button to save the change or the ↶ button to quit the function without making a change.



If you wish to change other settings, select the corresponding function from the OSD main menu. All the settings options in the main menu are described below.

OSD menu functions



The OSD menu for analogue monitor operation is described below. During digital operation some functions are not available, as they are not required due to the digital transmission technology used.

Adjusting the brightness and contrast

	Call up the <i>Brightness/Contrast</i> setting window
<i>Brightness</i>	Set the brightness of the display With this function you change the brightness of the background lighting.
<i>Contrast</i>	Set the contrast of the display With this function you modify the contrast of bright colour tones.
<i>Black level</i>	Set the brightness of the display With this function you modify the contrast of dark colour tones.
<i>ACR</i>	Enable/disable dynamic contrast This function improves the contrast by automatically controlling the background lighting in relation to the image being displayed. This setting can only be configured in <i>Video</i> application mode.
<i>Auto level</i>	Adjust the signal level With this function you can automatically set the contrast. The function is executed using →.



If the contrast is set too high, bright surfaces can no longer be distinguished from very bright surfaces. If the contrast is set too low, the maximum brightness will not be achieved.

Selecting the application mode

	Call up the <i>Mode</i> setting window
<i>D mode</i>	Setting for DICOM simulation (the values for color and ACR are locked: color = 7500K, ACR = off)
<i>sRGB</i>	Predefined setting for sRGB (reduced brightness)
<i>Office</i>	Office setting (the values for <i>color</i> and <i>sharpness</i> can be adjusted)
<i>Photo</i>	Predefined setting for photo (<i>colour</i> , <i>sharpness</i>)
<i>Video</i>	Predefined setting for video (<i>color</i> , <i>sharpness</i> , <i>ACR</i>)

Setting the screen display

	Open the <i>Image</i> setting window
<i>Phase</i>	Eliminate picture disturbance With this function you fine-tune your monitor to eliminate picture disturbance.
<i>Clock</i>	Set synchronisation With this function you adjust the picture width to eliminate vertical picture disturbances.
<i>H-Position</i>	Adjust the horizontal position With this function you move the picture to the left or to the right.
<i>V-Position</i>	Adjust the vertical position With this function you move the picture up or down.
<i>Sharpness</i>	Adjust the sharpness of the picture for the <i>Photo</i> and <i>Video</i> modes.
<i>Expansion</i>	Adjust the picture size <i>Full screen</i> = selection of full screen mode <i>Keep aspect</i> = maximum picture size without distortion

Adjusting the volume

	Call the <i>Audio</i> setting window
<i>Volume</i>	Set the volume for playback with the integrated loudspeakers
<i>Mute</i>	Switch the loudspeakers off or on
<i>Input</i>	Selecting the audio input signal (DP, PC Audio)

Setting colour temperature and colours

	Opening the <i>Color</i> setting window
	<p>Select the colour temperature</p> <p>The "warmth" of the screen colours is set using the colour temperature. The colour temperature is measured in Kelvin (K). You can choose between <i>6500 K</i>, <i>7500 K</i>, <i>9300 K</i>, <i>Native</i> and <i>Custom Color</i>.</p> <p>The options <i>Native</i> and <i>Custom Color</i> are only available in the <i>Office</i> setting mode.</p> <p>You can change the colour ratios of the basic colours (red, green, blue) as required using <i>Custom Color</i>. You can use → to select the colour channels.</p> <p>The <i>6500K</i> setting is recommended for general Windows applications.</p> <p>In the <i>Native</i> and <i>Custom Color</i> settings, the full colour space of the LCD panel can be used.</p>

Setting the OSD menu

	Call up the <i>OSD</i> window
<i>Language</i>	<p>Selecting the language for the OSD menu</p> <p>With this function you select the language for the OSD menu.</p> <p>The default setting is English.</p>
<i>Timeout</i>	<p>Setting the display duration of the OSD menu</p> <p>With this function you can select a value from 10 to 120 seconds.</p> <p>If the set time expires without a setting being made, the OSD menu is automatically hidden.</p>
<i>Rotation</i>	<p>Adjust the orientation of the OSD menu.</p> <p>This function can be used to turn the OSD menu through 90°.</p> <p>This function makes it easier to read the OSD menu while the pivot function is being used.</p> <p>This setting is available only on monitors that have a manual pivot function.</p>

Advanced setting functions

	Calling up the <i>Advanced</i> window
<i>Input select</i>	Select the input signal This function is used to select the input signal (VGA, DVI or DP). This is on condition that the display adapter supports this function.
<i>Overdrive</i>	Activating/deactivating the overdrive function This function can be used to improve the focus in fast moving images. This setting can only be configured in <i>Video</i> application mode.
<i>DDC-CI</i>	Activating/deactivating the DDC-CI function DDC-CI (Display Data Channel - Command Interface) Data can be exchanged through the connection between the PC and the display.
<i>Factory recall</i>	Activate the factory settings With this function all settings are reset to the factory settings on reconfirmation. The function is executed using \rightarrow . The <i>Auto Processing</i> message is displayed via a VGA data cable. The language selection menu appears.

Displaying information

	Call the <i>Information</i> setting window This function displays details such as the model designation, serial number, resolution, H/V frequency and ECO mode.
--	--

Notes on ergonomic colour adjustment



If you select colours for the monitor in your application programmes, take note of the information below.

The primary colours blue and red on a dark background do not produce the minimum required contrast of 3:1 and are therefore not suitable for continuous text and data entry.

When using several colours for characters and background and giving the primary colours full modulation, you can obtain very suitable colour combinations (see the following table):

Background	Characters							
	black	white	purple	blue	cyan	green	yellow	red
black		+	+	-	+	+	+	-
white	+		+	+	-	-	-	+
purple	+	+		-	-	-	-	-
blue	-	+	-		+	-	+	-
cyan	+	-	-	+		-	-	-
green	+	-	-	+	-		-	-
yellow	+	-	+	+	-	-		+
red	-	+	-	-	-	-	+	

+ Colour combination very suitable

- Colour combination not suitable because colour hues are too close together, thin characters are not identifiable or rigorous focusing is demanded of the human eye.

Troubleshooting

Should an error occur, first check the following points. If the distortion is still not eliminated, the monitor should, if possible, be checked on another computer.

If you cannot solve the problem, please contact our Service Desk.

Having this problem?	Check the following points:
No screen display Power indicator does not light up	<ul style="list-style-type: none"> ▶ Check whether the power cable on the monitor is connected correctly. ▶ Check whether the computer is switched on.
No screen display Power indicator is lit	<ul style="list-style-type: none"> ▶ Check whether the computer is switched on. ▶ Check whether the data cable for the monitor is correctly attached to the monitor port on the computer. ▶ Press any key on the computer keyboard. The computer may be in power saving mode. ▶ Alter the brightness and/or contrast until you get a picture.
Message: No Signal	<ul style="list-style-type: none"> ▶ Check whether the data cable for the monitor is correctly attached to the monitor port on the computer. ▶ Check whether the computer is switched on.
Message: Frequency out of range: ## kHz / ## Hz Please change the display mode to 1920 x 1080 with 60 Hz	<p>The input signal (horizontal frequency and refresh rate) at the displayed input does not correspond to the technical data for the monitor.</p> <ul style="list-style-type: none"> ▶ Adjust the video frequency range using the computer software (see documentation for the computer or display adapter). ▶ Set a different screen resolution using the computer software (see documentation for the computer or display adapter).
Picture position not correct	<p>The monitor recognises an undefined mode (see chapter "Technical specification", Page 35).</p> <ul style="list-style-type: none"> ▶ Press the AUTO button to conduct the auto-adjustment of the screen.
Picture is shaking	<ul style="list-style-type: none"> ▶ Check whether the data cable for the monitor is correctly attached to the monitor port on the computer. ▶ Press the AUTO button to conduct the auto-adjustment of the screen.
Picture is wrongly adjusted	<ul style="list-style-type: none"> ▶ Run the <i>Factory Recall</i> function in the OSD menu. <p>The <i>Auto Processing</i> message appears.</p>
Picture disturbances (vertical lines)	<ul style="list-style-type: none"> ▶ Press the AUTO button to conduct the auto-adjustment of the screen.

Having this problem?	Check the following points:
Picture disturbances (horizontal lines, picture noise)	<ul style="list-style-type: none"> ▶ Press the AUTO button to conduct the auto-adjustment of the screen.
The screen becomes darker	<p>The background lighting has a limited lifetime. If your monitor display should become too dark, the background lighting will have to be replaced.</p> <ul style="list-style-type: none"> ▶ Contact our Service Desk.

Explanatory information about standard ISO 9241-307

Permanently unlit or lit pixels

Today's production techniques cannot guarantee an absolutely fault-free screen display. Depending on the total number of pixels (resolution), there may be a few constantly lit or unlit pixels or subpixels.

Pixel	A pixel consists of 3 subpixels, normally red, green and blue. A pixel is the smallest element that can be generated by complete functionality of the display.
Subpixel	A subpixel is a separately addressable internal structure within a pixel that enhances the pixel function.

The maximum permitted number of faulty pixels is stipulated in the international standard ISO 9241-307. In accordance with standard ISO 9241-3, LCD monitors by Fujitsu comply with Class II for low resolutions and Class I for resolutions of 1680 x 1050 (1764000 pixel) and higher.

Examples:

A flat-screen monitor with a resolution of 1280 x 1024 has $1280 \times 1024 = 1310720$ pixels. Each pixel consists of three subpixels (red, green and blue), so there are almost 3.9 million subpixels in total. According to ISO 9241-3 (Class II), a maximum of 3 lit and 3 unlit pixels plus 7 lit or 13 unlit subpixels, or a corresponding combination, may be faulty (1 lit subpixel counts as two unlit subpixels).

A flat-screen monitor with a resolution of 1920 x 1080 has $1920 \times 1080 = 2073600$ pixels. Each pixel consists of three subpixels (red, green and blue), so there are almost 6.2 million subpixels in total. According to ISO 9241-3 (Class I), a maximum of 2 lit and 2 unlit pixels plus 5 lit or 10 unlit subpixels, or a corresponding combination, may be faulty (1 lit subpixel counts as two unlit subpixels).

Technical specification



Condensation is not permitted, neither in the rated range of operation nor in the limit range of operation.

Product name		B23T-7 LED
Model name		DY23T-7
Dimensions and weight		
Visible diagonals		58.4 cm
Dot pitch		0.2652 mm
Image size	Width	509 mm
	Height	286 mm
Maximum resolution		1920 x 1080
Dimensions incl. monitor base	Width	550 mm
	Height (min.)	357 mm
	Depth	204 mm
Weight (without packaging)		6.2 kg
Storable display modes		31
Pixel fault classes according to ISO 9241-307	Class	I
Electrical data		
Video	Analog	positive, 0.7 V _{ss} , 75 Ω
	Digital	DisplayPort/DVI-D with HDCP
Synchronisation		Separate Sync. TTL, positive or negative
Horizontal frequency		30 kHz ... 82 kHz (multi-scanning)
Refresh rate		48 Hz 76 Hz
Maximum pixel rate		VGA: 165 MHz Digital: 165 MHz
Power supply		automatic switching 100 V – 240 V, 50/60 Hz
Total power consumption (without audio, USB)	Normal operation	23 W
	ECO operating mode	19 W
	Power saving mode	< 0.35 W
Sound output		2.0 W left; 2.0 W right

Environmental conditions

Environment class 3K2, DIN IEC 721

Rated range of operation 15 °C 35 °C

Humidity 15 % 85 %

Limit range of operation 5 °C 35 °C

Humidity 15 % 85 %

VESA-DDC-compatible VGA interface

Your monitor is equipped with a VESA-DDC-compatible VGA interface. VESA-DDC (Video Electronics Standard Association, Display Data Channel) is used as the communications interface between the monitor and the computer. If the computer is equipped with a VESA-DDC-compatible VGA interface, it can automatically read the data for ensuring optimum operation from the monitor and select the appropriate settings.

Preset operating modes



The picture position and size have been set to optimum values at the factory for the operating modes listed above. Depending on the display adapter used, it may be necessary to adjust the display position or size. In this case, you can change and save the settings (see chapter "[Changing the monitor settings](#)", [Page 21](#)).

For ergonomic reasons, a screen resolution of 1920 x 1080 pixels is recommended. Because of the technology used (active matrix), an LCD monitor provides a totally flicker-free picture, even with a refresh rate of 60 Hz.

Most frequent operating modes

Screen resolution	Refresh rate
640 x 480	60/75 Hz
720 x 400	70 Hz
800 x 600	60/75 Hz
1024 x 768	60/75 Hz
1280 x 720	60 Hz
1280 x 1024	60/75 Hz
1366 x 768	60 Hz
1440 x 900	60 Hz
1600 x 900	60 Hz
1680 x 1050	60 Hz
1920 x 1080	60 Hz
1920 x 1200	60 Hz

SUB D port

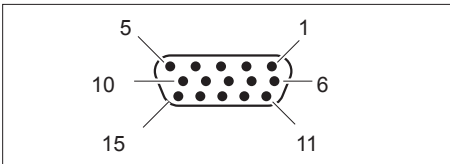

Pin	Meaning
1	Video input red
2	Video input green
3	Video input blue
4	Ground
5	Ground
6	Video ground red
7	Video ground green
8	Video ground blue
9	+5 V (DDC)
10	Sync. ground
11	Ground
12	DDC Data
13	H. sync
14	V. sync
15	DDC Clock

DVI-D port

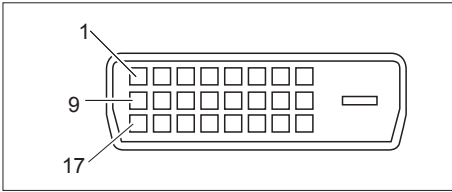

Pin	Meaning
1	TMDS Data2-
2	TMDS Data2+
3	TMDS Data 2/4 Shield
4	not connected
5	not connected
6	DDC Clock
7	DDC Data
8	Analog Vertical Sync
9	TMDS Data1-
10	TMDS Data1+
11	TMDS Data 1/3 Shield
12	not connected
13	not connected
14	+5V Power
15	Earth
16	Hot Plug Detect
17	TMDS Data0-
18	TMDS Data0+
19	TMDS Data 0/5 Shield
20	not connected
21	not connected
22	TMDS Clock Shield
23	TMDS Clock+
24	TMDS Clock-

DisplayPort socket

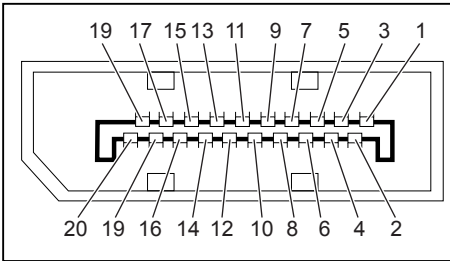

Pin	Meaning
1	Lane 3 (negative)
2	Earth
3	Lane 3 (positive)
4	Lane 2 (negative)
5	Earth
6	Lane 2 (positive)
7	Lane 1 (negative)
8	Earth
9	Lane 1 (positive)
10	Lane 0 (negative)
11	Earth
12	Lane 0 (positive)
13	Connected to earth
14	Connected to earth
15	Auxiliary channel (positive)
16	Earth
17	Auxiliary channel (negative)
18	Hot Plug Detect
19	Return for Power
20	Power for connector (3.3 V 500 mA)